

|               |               |                      |
|---------------|---------------|----------------------|
| AISI304 Satin | AISI316 Satin | Beskrivning          |
| E0222         | E0222316      | Svetsas mot ledstång |

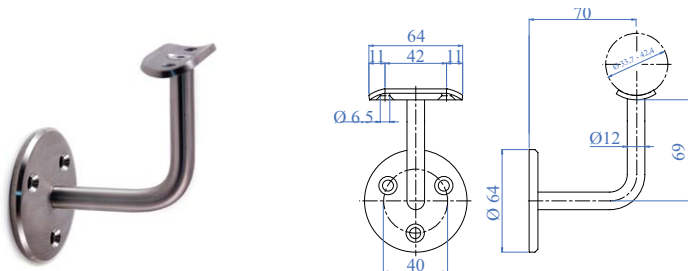

|         |            |                   |      |
|---------|------------|-------------------|------|
| AISI304 | AISI316    | För handledare mm | Hörn |
| E011971 | E011971316 | Ø33,7 - Ø42,4     | 90°  |
| E011970 | E011970316 | Plant             | 90°  |



|               |               |                 |            |
|---------------|---------------|-----------------|------------|
| AISI304 Satin | AISI316 Satin | AISI316 Polerad | För rör mm |
| E0223         | E0223316      | X0223316        | Ø33 - Ø43  |



|         |            |                   |
|---------|------------|-------------------|
| AISI304 | AISI316    | För handledare mm |
| E01197  | E01197316  | Ø33,7 - Ø42,4     |
| E011976 | E011976316 | Plant             |

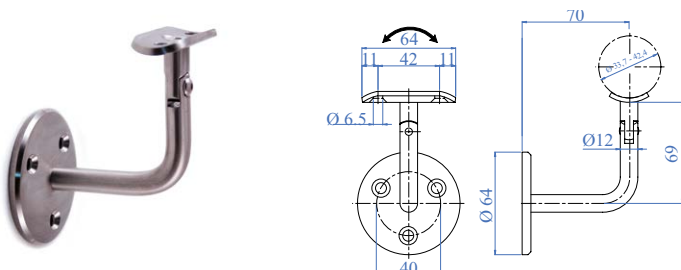

|               |               |                 |            |
|---------------|---------------|-----------------|------------|
| AISI304 Satin | AISI316 Satin | AISI316 Polerad | För rör mm |
| E02231        | E02231316     | X02231316       | Ø33 - Ø43  |

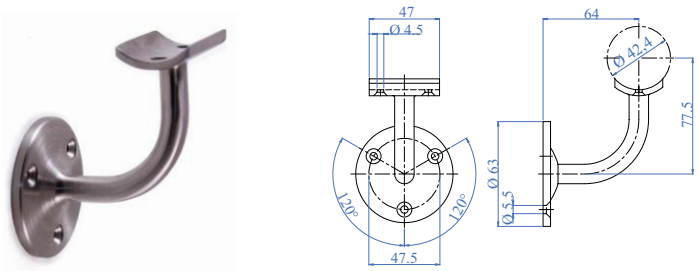

|               |                 |            |
|---------------|-----------------|------------|
| AISI316 Satin | AISI316 Polerad | För rör mm |
| E459          | X459            | Ø 42,4     |

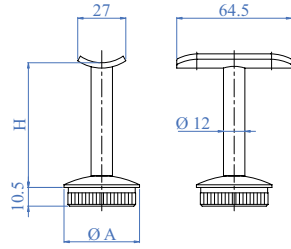

| AISI303 Satin | AISI316 Satin | AISI316 Polerad | Höjd H mm | För rör ØA mm |
|---------------|---------------|-----------------|-----------|---------------|
| E030/S        | E030/S316     | X030/S316       | 75        | Ø 42,4 x 2,0  |

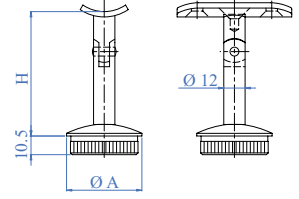

| AISI303 Satin | AISI316 Satin | AISI316 Polerad | Höjd H mm | För rör ØA mm |
|---------------|---------------|-----------------|-----------|---------------|
| E031/S1       | E031/S1316    | X031/S1316      | 75        | Ø 42,4 x 2,0  |

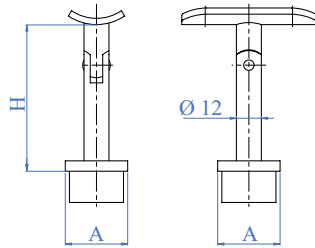

| AISI304 Satin | AISI316 Satin | Höjd H mm | För rör A mm  |
|---------------|---------------|-----------|---------------|
| E037200       | E037210       | 75        | 40 x 40 x 2,0 |

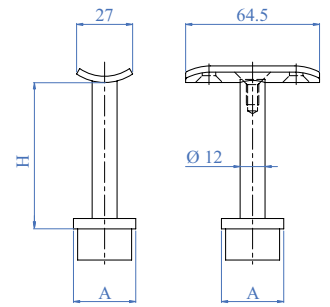

| AISI304 Satin | AISI316 Satin | Höjd H mm | För rör A mm  |
|---------------|---------------|-----------|---------------|
| E037600       | E037610       | 75        | 40 x 40 x 2,0 |

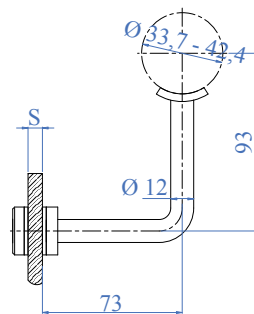

| AISI303 Satin | AISI316 Satin | Beskrivning mm         |
|---------------|---------------|------------------------|
| E035100       | E035100316    | Glas 8-22, borrhål Ø21 |

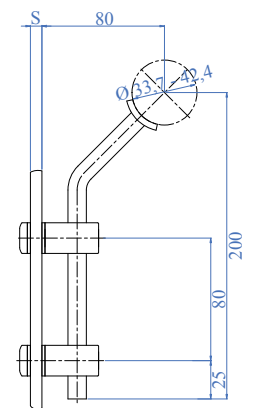

| AISI303 Satin | AISI316 Satin | Beskrivning mm         |
|---------------|---------------|------------------------|
| E035300       | E035300316    | Glas 8-22, borrhål Ø15 |